

Prediction of COVID-19 Cases in West Nusa Tenggara using SEIQR Model

Lalu Tarangga Arief Gunawan¹, Albert Hosea², Prihantini³

¹Department of Computer Science, Faculty of Science, Gadjah Mada University

²Department of Mathematics, Faculty of Science, Gadjah Mada University

³Department of Mathematics, Faculty of Science, Bandung Institute of Technology

²Jl. Sekip Utara Bulaksumur Yogyakarta 55281, Indonesia. Tel. +62-274-513339, Fax. +62-274-513339.

³Jl. Ganesha No. 10 Bandung West Java 40132, Indonesia. Tel. +62-222-515032, Fax. +62-222-502360.

Email : ¹tarangga.arief@mail.ugm.ac.id, ²albert.h.s.@mail.ugm.ac.id, ³titinprihantini4@gmail.com

Abstract. On March 17, 2020 a patient have tested positive for COVID-19. That case become the first confirmed case in the West Nusa Tenggara (NTB), Indonesia. These cases continued to grow over time until September 14, 2020 Which brings the total number of positive cases to 2979. COVID-19 can transmit through direct or indirect contact with infected people's vomit, urine, feces, or airborne transmission. People who are infected, develop symptoms, or travel between provinces or even countries must be quarantined for 14 days to prevent further spread of COVID-19. A person who survives after quarantine will develop new immune system so that he/she can't get infected twice. Therefore the appropriate mathematical modeling is SEIQR modeling which stands for susceptible, exposed, symptomatic infected, quarantine, and recover. In this paper, we will conduct SEIQR modeling on COVID-19 in NTB using data obtained from corona.ntbprov.go.id, which is the official website of the government of NTB. From those data, we will obtain the model and also growth chart. The result of our study is growth chart of COVID-19 in NTB.

Keywords: COVID, SEIQR, Quarantine, Predict.

Abbreviations: WHO (World Health Organization).

Running title: Prediction of COVID-19 using SEIQR model.

INTRODUCTION

In December 2019, the world was shocked by the appearance of a virus identified in the Wuhan city, Hubei Province of China. In February 11th 2020, the outbreak of this virus became the global attention, especially by International World Health Organization (WHO) which informed this virus as the new coronavirus called the 2019 coronavirus (COVID-19). The source of COVID-19 has not been determined so far. Various evidence shows that the source of COVID-19 infection comes from bats and some wild animals which are sold at the Huanan seafood market, Wuhan city. COVID-19 human-to-human transmission mainly through direct or indirect contact with infected people's vomit, urine, feces or airborne transmission

The first case of COVID-19 in Indonesia was announced by the COVID-19 National Task Force on March 2nd, 2020. For a regional case that became the concern of this paper is the cases in West Nusa Tenggara. COVID-19 cases identified in East Lombok on March 23th 2020, in Mataram city on March 30th 2020, in Sumbawa and other province on March 31th 2020, in Central Lombok on April 2nd 2020, in West Lombok on April 8th 2020, in North Lombok on April 9th 2020, in Bima city on April 14th 2020, in Dompu on April 18th 2020, in West Sumbawa on April 19th 2020, and in Bima Regency on April 20th 2020. In table 1, it can be seen that the number of COVID-19 cases reported on a daily basis has increased from day to day.

Table 1. Number of COVID-19 cases in NTB from September 6th 2020 until September 15th 2020.

Date	Suspects	Confirmed cases
6 September 2020	11040	2874
10 September 2020	11143	2922
15 September 2020	11272	3006

As shown in table 1, the number of cases in West Nusa Tenggara is always increasing on a daily basis. People who infected, develop symptoms or travel between provinces or even countries must be quarantined for 14 days to prevent further spread of COVID-19. A person who survives after quarantine will develop new immune system so that he/she can't get infected twice. Therefore the appropriate mathematical modeling is SEIQR modeling which stands for susceptible, exposed, symptomatic infected, quarantine and recover. The purpose of this research is to conduct SEIQR modeling for the spread of the COVID-19 virus epidemic in West Nusa Tenggara using data obtained from corona.ntbprov.go.id, which is the official website of the government of NTB. From those data, we will obtain the model and also growth chart which can help to act appropriately and minimize the impact of the epidemic risk of the COVID-19 outbreak. The result of our study is growth chart of COVID-19 in NTB.

MATERIALS AND METHODS

Study area

The dataset used in this research is COVID growth in Nusa Tenggara Barat (NTB), Indonesia, from August 9th to October 17th 2020. The dataset contains six fields, and

there are the weeks, number of susceptible individuals (denoted as S), number of exposed individuals (denoted as E), number of infected individuals (denoted as I), number of quarantined individuals (denoted as Q), number of recovered individuals (denoted as R). The total number of the data is 71, with 23 data in August, 30 data

in September, and 18 data in October. The programs used to analyze descriptive and predictive analysis in this study are Python, Pandas, and Microsoft Excel.

Procedures

The procedure for this research can be seen in figure 1.1

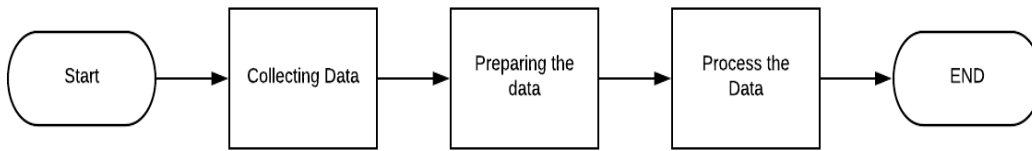

Figure 2.1 Research Flowchart.

• **Collecting Data**

The data obtained came from corona.go.id. The data shows the growth of suspect cases, the number of positives, and the travel data each day. The data on this website is in html form, so we use web crawler to collect the data.

• **Preparing the data**

The data that has been collected needs to be processed first. The data that was previously in the form of days need to be converted into week data. After the data is changed, the data will be processed so that the parameters to make

predictions can be obtained.

• **Process the data**

The model we use to predict COVID 19 in NTB is SEIQR model. SEIQR model is stand for susceptible, exposed, symptomatic infective (is), quarantine and recovered. The model is applied using Euler method so that the calculation process becomes simpler, number of.

Data analysis

Model of COVID-19 with SEIQR Model

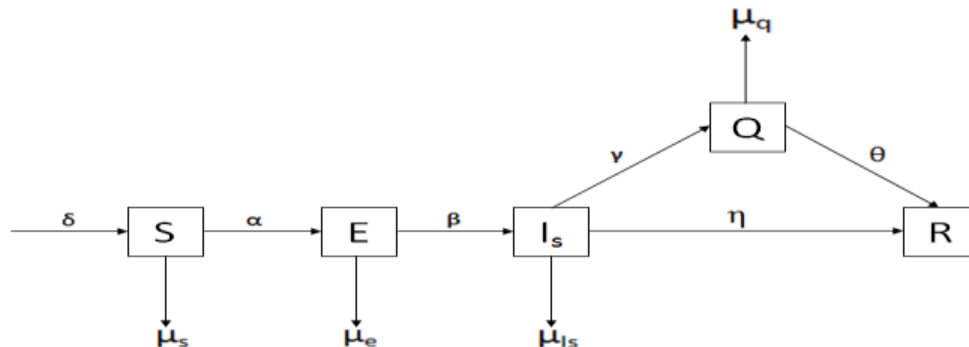

Figure 2.2 Input-output diagram for the SEIQR model of COVID-19.

From Input-output diagram model in Figure 1, we get differential equation nonlinear as follow:

$$\frac{ds}{dt} = \delta - \alpha s(t) \frac{i_s(t)}{N} - \mu s(t) \quad s(0) > 0 \quad (1)$$

$$\frac{de}{dt} = \alpha s(t) \frac{i_s(t)}{N} - \beta p e(t) - \mu e(t) \quad e(0) \geq 0 \quad (2)$$

$$\frac{dis}{dt} = \beta p e(t) - \theta i_s(t) - \mu i_s(t) \quad i_s(0) > 0 \quad (3)$$

$$\frac{dq}{dt} = \nu i_s(t) - \rho q(t) - \mu q(t) \quad q(0) > 0 \quad (4)$$

$$\frac{dr}{dt} = \theta i_s(t) - \mu r(t) \quad r(0) > 0 \quad (5)$$

$$N(t) = s(t) + e(t) + i_s(t) + q(t) + r(t) \quad (6)$$

Description

Table 2.1 SEIQR Model parameter.

Date	Suspects
δ	Constant birth rate
μ	Constant dead rate by COVID-19
α	Transmission rate of COVID-19
β	Probability of transmitting COVID-19
θ	Period of COVID-19 incubation in humas
ρ	Recovery rate

Euler’s Method

Euler’s method is an approximation method for solving initial-value problems. Given a well-posed initial value problem:

$$\frac{dy}{dt} = f(t,y), \quad a \leq t \leq b, \quad y(a) = \alpha \quad (12)$$

First, we choose a positive integer N, and define $h = (b - a)/N$ and select mesh points in interval $[a, b]$:

$$t_i = a + ih, \text{ for each } i = 0, 1, 2, \dots, N$$

Suppose that $y(t)$, the unique solution for (12), has two continuous derivative on $[a, b]$, so that for each $i = 0, 1, \dots, N-1$, we have

$$y(t_{i+1}) = y(t_i) + (t_{i+1}-t_i)y'(t_i) + \frac{(t_{i+1}-t_i)^2}{2}y''(\xi_i),$$

for some ξ_i in (t_i, t_{i+1}) . Because $h = t_{i+1}-t_i$, then

$$y(t_{i+1}) = y(t_i) + hy'(t_i) + \frac{h^2}{2}y''(\xi_i),$$

and because $y(t)$ is the unique solution of (12) then

$$y(t_{i+1}) = y(t_i) + hf(t_i, y(t_i)) + \frac{h^2}{2}y''(\xi_i),$$

Euler’s method constructs $w_i \approx y(t_i)$, for each $i = 1, 2, \dots, N$ by deleting the remainder term. So, Euler’s method is

$$w_0 = \alpha,$$

$$w_{i+1} = w_i + hf(t_i, w_i), \text{ for each } i = 0, 1, \dots, N-1$$

RESULTS AND DISCUSSION

In this study we assume that all people who have COVID will self-isolate, there will be no births, and that death only occurs due to COVID. After do some calculation we get that $N = 5125622$, $E(0) = 10105$, $I(0) = 2315$, $Q(0) = 748$, $R(0) = 14139$, $S(0) = 5106868$, $\delta = 0.0/\text{week}$, $\sigma = 0.014946448917251071/\text{week}$, $\alpha = 2.7680 \cdot 10^{-5}/\text{week}$, $\beta = 0.2538697624457402$, $\theta = 1$, $IP = 14$, dan $\rho = 1/14$. Using python code that applied SEIQR model and euler method we get result:

Table 2.2 Number of S,E,I,Q,R from week 0 (August 9th 2020) till week 99 (July 12th 2022)

week	S	E	I	Q	R
0	5106868	12048	3699	483	3007
1	5031105	11656	1475	2390	3477
2	4956467	11276	664	2626	4205
3	4882937	10909	366	2370	4916
4	4810497	10554	254	2019	5536
...
95	1234508	520	9	36	12796
96	1216193	503	9	35	12806

97	1198151	486	8	34	12816
98	1180376	470	8	32	12826
99	1162864	455	8	31	12835

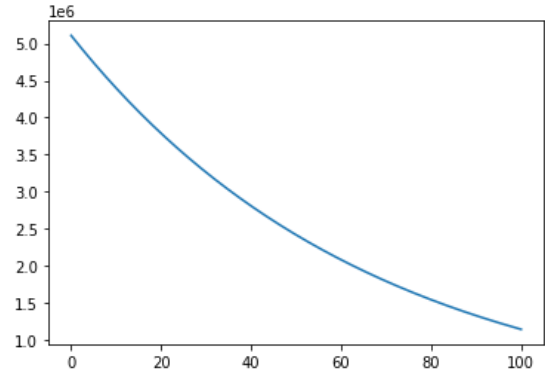

Figure 2.3 Susceptible Graph.

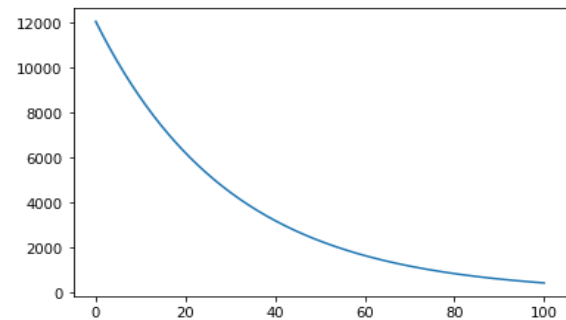

Figure 2.4 Exposed Graph.

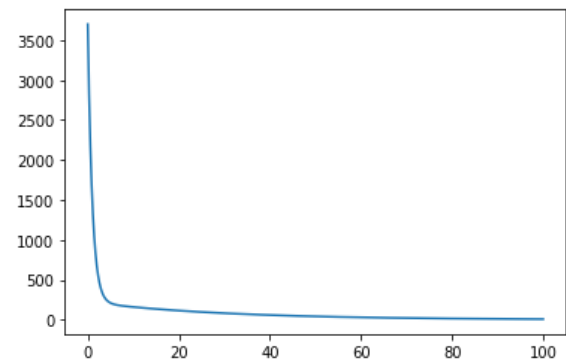

Figure 2.5 Infective Graph.

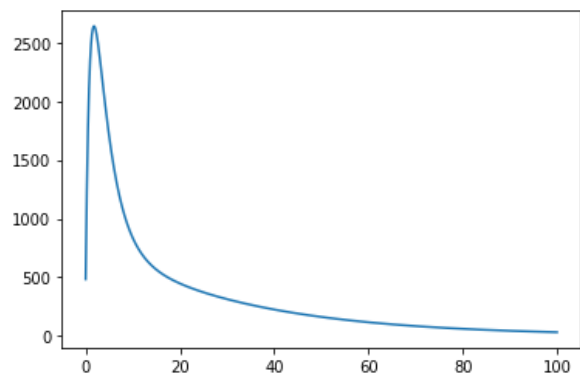

Figure 2.6 Quarantine Graph.

CONCLUSIONS

The data used in this research was from the government website corona.ntbprov.go.id. In this research we use the SEIQR model and euler method to predict the number of susceptible, exposed, infected, quarantined, and recovered. This model shows us that susceptible, exposed, infected, quarantined will be decreased and recovered will be increased. This model also gives us insight that the people who are infected by COVID 19 will drop under 10 at week 94.

ACKNOWLEDGEMENTS

We thank our colleagues from Gadjah Mada University and Bandung Institute of Technology for providing insights and expertise that greatly assisted this research. We also thank the government of NTB and WHO for providing data about COVID-19, which is really important for our research. Our completion of this project could not have been accomplished without the support of each other.

REFERENCES

- Burden, Richard L., Fairies, J.D., Burden, A.M. 2014. Numerical Analysis. Cengage Learning, United States.
- Dinas Komunikasi, Informatika dan Statistik Provinsi Nusa Tenggara Barat. 2020. Hystory Data. <https://corona.ntbprov.go.id/all-list-data>.
- Hyman, J.M., Li, J. 2000. An Intuitive Formulation for the Reproductive Number for the Spread of Diseases in Heterogeneous Populations. *Mathematical Biosciences* 167(1). 65-86.
- Jumpen, W., Wiwatanapataphee, B., Wu, Y.H., Tang, L.M. 2009. A SEIQR Model for Pandemic Influenza and its Parameter Identification. *International Journal of Pure and Applied Mathematic* 52(2).247-265.
- Mollison, Denis. 1995. *Epidemic Models: Their Structure and Relation to Data*. Cambridge University Press, New York.
- Saptaningtyas, F.Y., Prihantini. 2017. Stability analysis model of *Bacillus antracis* using SEIQR population compartment with quarantine in Indonesia. *International Conference on Mathematics Series: Journal of Physics* 983(1):012088.
- World Health Organization. 2020. Coronavirus disease (COVID-19) pandemic. <https://www.who.int/emergencies/diseases/novel-coronavirus-2019>.

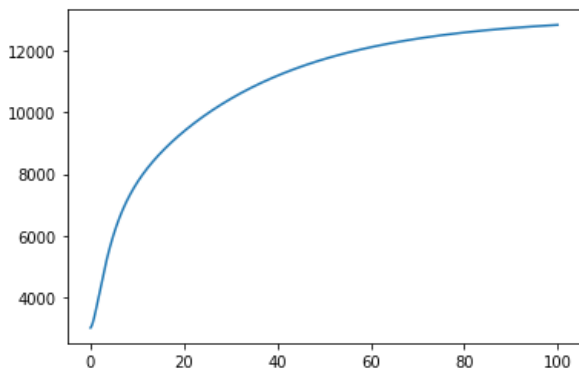

Figure 2.7 Quarantine Graph.

Discussion

Table 2.2 Describe the number of susceptible, exposed, infected, quarantined, recovered individuals in NTB every weeks from August 9th 2020 until July 12th 2022. This table also shows that on June 7th 2022 the population of infected people will drop under 10.

Figure 2.3 is Susceptible Graph, this graph shows that the susceptible population will decrease, this is because the population will change to exposed, infected, or recovery population. Figure 2.4 is Exposed Graph This graph decreases over the time due to the decreased amount of susceptible. Figure 2.5 is Infected Graph This graph describes that the number of people who have COVID will decrease. The cause of the decrease in the number is in line with the decrease in the number of Exposed people. Figure 2.6 is Quarantine Graph, This graph describes that the number of quarantines will increase and after that will decrease after some amount of time. This happened because for the first time there were so many people who got infected by COVID and after that the number of infective people decreased as did the number of quarantine people. The last Figure, Figure 2.7 tells that the number of people who will recover will be increased.